



### DIN RAIL SMART METER FOR SINGLE AND THREE PHASE ELECTRICAL SYSTEMS

User Manual

#### Safety Instruction

The installation instructions do not include a complete list of all safety measures necessary for operating the device. Special operating conditions may require additional measures. The installation instructions contain notes that must be observed for your personal safety to prevent property damage. Safety instructions in this document are highlighted with a warning triangle and are presented as follows depending on the level of risk.

The general warning symbol calls attention to possible risks of injury. Observe all the instructions listed under the symbol to prevent injuries or even death.

This additional symbol indicates any electrical danger that can result in serious injuries or death.

#### Attention

Warns of an imminently dangerous situation that can result in property damage or environmental damage in the event of noncompliance.

## 1.Introduction

This document provides operating, maintenance and installation instructions. These units measure and display the characteristics of single phase two wire (1p2w), three phase three wire (3p3w) and three phase four wire (3p4w) networks. The measuring parameters include voltage (V), frequency (Hz), current (A), power (kW/kVA/kVAh), import, export and total Energy (kWh/kVAh). The units can also measure maximum demand current and power, this is measured over preset periods of up to 60 minutes.

These units are Max. 100A direct connected and do not need to connect with external current transformers (CT). The unit is built-in with pulse, RS485/Modbus outputs. Configuration is password protected.

### 1.1 Unit Characteristics

The SDM630 100A V2 series meters have 7 models: SDM630-Pulse V2, SDM630-MT V2, SDM630-Mbus V2, SDM630-Modbus V2, SDM630-Standard V2, SDM630-2T V2 and SDM630-Mbus-2T.

Model	Measurement	Communication	Tariff
SDM630-Pulse V2	kWh/kVAh, kW/kVA, kVA, P, F, PF, dmd, V, A, THD, etc.	NO	NO
SDM630-Standard V2	kWh/kVAh	RS485 Modbus	NO
SDM630-Modbus V2	kWh/kVAh, kW/kVA, kVA, P, F, PF, dmd, V, A, THD, etc.	RS485 Modbus	NO
SDM630-Mbus V2	kWh/kVAh, kW/kVA, kVA, P, F, PF, dmd, V, A, THD, etc.	Mbus EN13757-3	NO
SDM630-MT V2	kWh/kVAh, kW/kVA, kVA, P, F, PF, dmd, V, A, THD, etc.	RS485 Modbus	4 Tariffs (RTC)
SDM630-2T V2	kWh/kVAh, kW/kVA, kVA, P, F, PF, dmd, V, A, THD, etc.	RS485 Modbus	2 Tariffs (dual source)
SDM630-Mbus-2T	kWh/kVAh, kW/kVA, kVA, P, F, PF, dmd, V, A, THD, etc.	Mbus EN13757-3	2 Tariffs (dual source)

### 1.2 RS485 Serial-Modbus RTU

\*Not for SDM630-Pulse V2, SDM630Mbus V2 or SDM630Mbus-2T

RS485 serial port with Modbus RTU protocol to provide a means of remotely monitoring and controlling the unit. Set-up screens are provided for setting up the RS485 port. Refers to section 4.2

### 1.3 Mbus

\*For SDM630-Mbus V2 and SDM630Mbus-2T only

This uses a Mbus port with EN13757-3 protocol to provide a means of remotely monitoring and controlling the unit. Set-up screens are provided for setting up the Mbus port. Refers to section 4.2

\*If the Modbus / Mbus protocol document is required, please contact us for it.

### 1.4 Pulse Output

The meter provides two pulse outputs for active and reactive energy measurement. Both pulse outputs are passive type. The constant of pulse output 2 for active energy is 400imp/kWh (Unconfigurable), its width is fixed at 100ms.

The default constant of pulse output 1 is 400imp/kWh, default pulse width is 100ms. Both pulse constant and pulse width are configurable through set-up menu or communication. Refers to section 4.3

### 1.5 Dual Power Source for SDM630-2T

The meter can measure energy from two different power supplies. For example, when public grid is power off and electric generator is on, the meter switches to tariff 2 measurement automatically. The meter can also be used as a tariff meter. The tariff is controlled by an external time relay. Itself doesn't measure or record time information.

### 1.6 4T by RTC for SDM630-MT

The internal clock circuit of this unit has time automatic switching function. Calendar, clock and rate can be set and adjusted through RS485, at least 4 tariffs and 8 time segments which can be set within a natural day.

## 2.Start Up Screens

1.L1,2 MD % (IMPORT) EXPORT

L1-2 T -8.8.8.8 MkWh

L2-3 N Σ -8.8.8.8 V%THD

L3-1 -8.8.8.8 Hz

⊗ -8.8.8.8 MkVA

⊙ -8.8.8.8 PF C1 C2

The first screen lights up all display segments and can be used as a display check.

Soft  
1302  
2014

Software version information  
(This information is for reference only, in kind prevail.)

InSt  
tEst  
PRSS

The interface performs a self-test and indicates the result if the test passes.

\*After a short delay, the screen will display active energy interface as follows:

0000 kWh

Σ 03.14

Total active energy in kWh.

## 3.Measurements

The buttons operate as follows:

	Selects the Voltage and Current display screens. In Set-up Mode, this is the "Left" or "Back" button.
	Select the Frequency and Power factor display screens. In Set-up Mode, this is the "Up" button.
	Select the Power display screens. In Set-up Mode, this is the "Down" button.
	Select the Energy display screens. In Set-up mode, this is the "Enter" or "Right" button.

### 3.1 Voltage and Current

\*Not for SDM630-Standard V2.

Each successive press of the U/I button selects a new parameter:

L1 L2 L3	0000 V 0000 0000	Phase to neutral voltages.
L1 L2 L3	0000 A 0000 0000	Current on each phase.
L1 L2 L3	00.00 V%THD 00.00 00.00	Phase to neutral voltage THD%
L1 L2 L3	00.00 I%THD 00.00 00.00	Current THD% for each phase

### 3.2 Frequency and Power Factor and Demand

\*Not for SDM630-Standard V2

Each successive press of the M button selects a new range:

Σ	0000 Hz 0.999 PF	Frequency and Power Factor (total).
L1 L2 L3	0.999 0.999 0.999 PF	Power Factor of each phase.
L1 L2 L3	MD 0000 A 0000 0000	Maximum Current Demand.
Σ	MD 0000 kW 0000	Maximum Power Demand.

### 3.3 Power

\*Not for SDM630-Standard V2

Each successive press of the P button select a new range:

L1 L2 L3	0000 kW 0000 0000	Instantaneous Active Power in kW.
L1 L2 L3	0000 kVA 0000 0000	Instantaneous Reactive Power in kVA.
L1 L2 L3	0000 0000 0000 kVA	Instantaneous Volt-Amps in kVA.

0000 kW  
Σ 0000 kVA  
0000

Total kW, kVA, kVA.

## 3.4 Energy Measurements

Each successive press of the E button selects a new range:

0000 kWh Σ 03.14	Total active energy in kWh.
(IMPORT) 0000 kWh 03.14	Import active energy in kWh. *not shown on SDM630-2T
(EXPORT) 0000 kWh 00.00	Export active energy in kWh. *not shown on SDM630-2T
T 1 0000 kWh 00.00	Tariff 1~4 active energy *For SDM630-MT V2 only Tariff 1~2 active energy *For SDM630-2T V2 and SDM630Mbus-2T
Σ 0000 kVAh 00.00	Total reactive energy
(IMPORT) 0000 kVAh 00.00	Import reactive energy *not shown on SDM630-2T
(EXPORT) 0000 kVAh 00.00	Export reactive energy *not shown on SDM630-2T
T 1 0000 kVAh 00.00	Tariff 1~4 reactive energy *For SDM630-MT V2 only Tariff 1~2 reactive energy *For SDM630-2T V2 and SDM630Mbus-2T
DATE 2000 01.01	Date Year/month/day. 1st,Jan,2000 (default) *For SDM630-MT V2 only
T 1 00:02 :16	Time Hour/minute/second Example:00:02:16 *For SDM630-MT V2 only

\*The parameters of date and time can only be set via RS485 communication.

## 4.Set Up

To enter set-up mode, press the E button for 3 seconds until the password screen appears.

PRSS 0000	Setting up is password-protected. The user must enter the correct password (default '1000') before processing.
PRSS Err	If an incorrect password is entered, the display will show: PASS Err

To exit setting-up mode, press U/I repeatedly until the measurement screen is restored.

### 4.1 Set-up Entry Methods

Some menu items, such as password, require a four-digits number entry while others, such as supply system, require selection from a number of menu options.

#### 4.1.1 Menu Option Selection

- Use the M and P buttons to scroll through the different options of the set up menu.
- Press E to confirm your selection
- If an item flashes, then it can be adjusted by the M and P buttons.
- Having selected an option from the current layer, press E to confirm your selection.
- Having completed a parameter setting, press U/I to return to a higher menu level, and you will be able to use the M and P buttons for further menu selection.
- On completion of all setting-up, press U/I repeatedly until the measurement screen is restored.

#### 4.1.2 Number Entry Procedure

When setting up the unit, some screens require the entering of a number. In particular, on entry to the setting up section, a password must be entered. Digits are set individually, from left to right. The procedure is as follows:

- The current digit to be set flashes and is set using the M and P buttons
- Press E to confirm each digit setting.
- After setting the last digit, press U/I to exit the number setting routine.

## 4.2 Communication

### 4.2.1 RS485/Modbus Primary Address

\*Not for SDM630-Pulse V2

SEt  
Addr  
001

(The range is from 001 to 247 for Modbus and 001 to 250 for Mbus)

SEt Addr 001	From the set-up menu, press M and P buttons to select the address ID.
SEt Addr 101	Press E button to enter the selection routine. The current setting will flash.
SEt Addr 101	Use M and P buttons to choose Modbus or Mbus primary address

Press E to confirm the setting and press U/I to return to the main set up menu.

### 4.2.2 Mbus Secondary Address

\*For SDM630-Mbus V2 and SDM630Mbus-2T

- 1d - 9999 9999	Secondary address: 00 00 00 01 to 99 99 99 99
- 1d - 9999 9999	From the set-up menu, use M and P buttons to find the setting page.
- 1d - 9999 9999	Press E to enter the selection routine. The current setting will flash.
- 1d - 1193 8171	Use M and P buttons to set the secondary address

Press E to confirm the setting and press U/I to return to the main set up menu.

### 4.2.3 Baud Rate

Baud rate range for Modbus RTU: 2.4k, 4.8k, 9.6k, 19.2k, 38.4k. For Mbus: 0.3k, 0.6k, 2.4k, 4.8k, 9.6k.

SEt bAUD 9.6 k	From the set-up menu, use M and P buttons to select the baud rate option.
SEt bAUD 9.6 k	Press E to enter the selection routine. The current setting will flash.
SEt bAUD 9.6 k	Use M and P buttons to choose baud rate.

Press E to confirm the setting and press U/I to return to the main set up menu.

### 4.2.4 Parity

SEt PARI EVEN	From the set-up menu, use M and P buttons to select the parity option.
SEt PARI EVEN	Press E to enter the selection routine. The current setting will flash.
SEt PARI NONE	Use M and P buttons to choose parity (EVEN / ODD / NONE).

Press E to confirm the setting and press U/I to return to the main set up menu.

### 4.2.5 Stop Bits

SEt StOP 2	From the set-up menu, use M and P buttons to select the stop bit option.
SEt StOP 2	Press E to enter the selection routine. The current setting will flash.

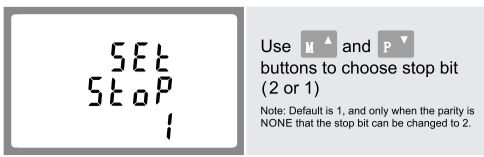

Use **M** and **P** buttons to choose stop bit (2 or 1)  
 Note: Default is 1, and only when the parity is NONE that the stop bit can be changed to 2.

Press **E** to confirm the setting and press **U/I** to return to the main set up menu.

### 4.3 Pulse Output

This option allows you to configure the pulse output 1. The output can be set to provide a pulse for a defined amount of energy active or reactive. Use this section to set up the pulse output for:

- Toal kWh/Total kVArh
- Import kWh/Export kWh
- Import KVArh/Export KVArh

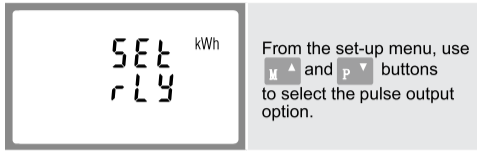

From the set-up menu, use **M** and **P** buttons to select the pulse output option.

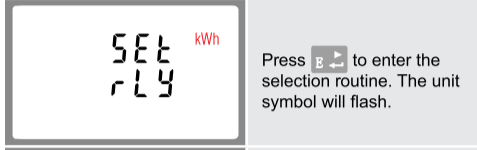

Press **E** to enter the selection routine. The unit symbol will flash.

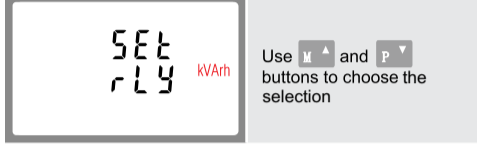

Use **M** and **P** buttons to choose the selection

Press **E** to confirm the setting and press **U/I** to return to the main set up menu.

#### 4.3.1 Pulse Rate

Use this to set the energy represented by each pulse. Rate can be set to 1 pulse per dFt/0.01/0.1/1/10/100kWh/kVArh.



(It shows 1 pulse = 10kWh/kVArh)

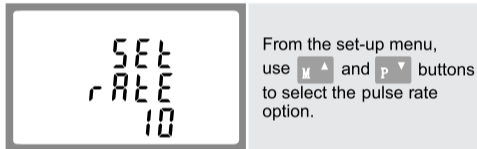

From the set-up menu, use **M** and **P** buttons to select the pulse rate option.

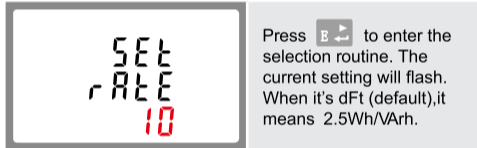

Press **E** to enter the selection routine. The current setting will flash. When it's dFt (default), it means 2.5Wh/VArh.

Use **M** and **P** buttons to choose pulse rate, then press **E** to confirm the setting and press **U/I** to return to the main set up menu.

#### 4.3.2 Pulse Duration

The pulse width can be selected as 200, 100 (default) or 60ms.



(It shows pulse width of 100ms)

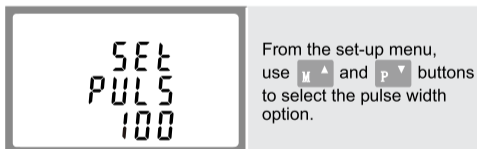

From the set-up menu, use **M** and **P** buttons to select the pulse width option.



Press **E** to enter the selection routine. The current setting will flash.

Use **M** and **P** buttons to choose pulse rate, then press **E** to confirm the setting and press **U/I** to return to the main set up menu.

### 4.4 DIT Demand Integration Time

**\*Not for SDM630-Standard V2**

This sets the period in minutes over which the current and power readings are integrated for maximum demand measurement. The options are: 0, 5, 8, 10, 15, 20, 30, 60 minutes.

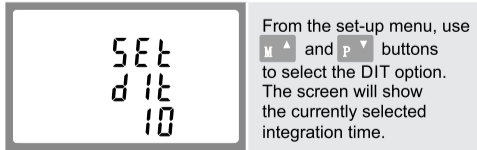

From the set-up menu, use **M** and **P** buttons to select the DIT option. The screen will show the currently selected integration time.

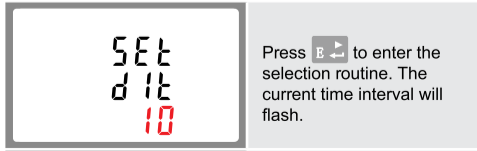

Press **E** to enter the selection routine. The current time interval will flash.

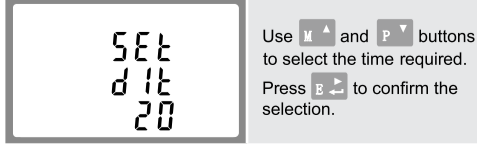

Use **M** and **P** buttons to select the time required. Press **E** to confirm the selection.

Press **U/I** to exit the DIT selection routine and return to the menu.

### 4.5 Backlit Set-up

Backlit lasting time is settable, default lasting time is 60minutes



it is set as 5, the backlit will be off in 5 minutes if there is no more further operation.

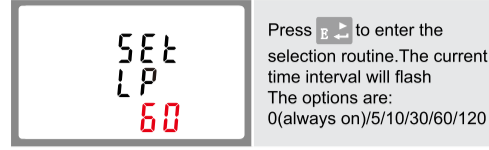

Press **E** to enter the selection routine. The current time interval will flash. The options are: 0 (always on)/5/10/30/60/120

Press **M** and **P** to select the time interval. Then press **E** to confirm the set-up.

### 4.6 Supply System

The unit has a default setting of 3 phase 4 wire (3P4W) Use this section to set the type of electrical system.

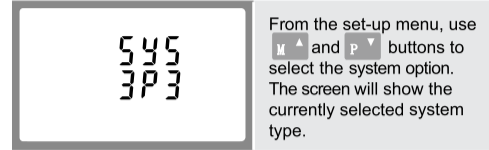

From the set-up menu, use **M** and **P** buttons to select the system option. The screen will show the currently selected system type.



Press **E** to enter the selection routine. The current selection will flash.

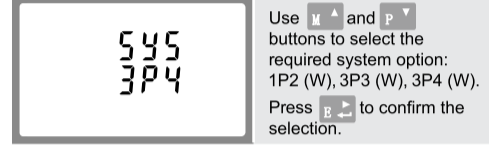

Use **M** and **P** buttons to select the required system option: 1P2 (W), 3P3 (W), 3P4 (W). Press **E** to confirm the selection.

Press **U/I** to exit the system selection routine and return to the menu.

### 4.7 CLR

**\*Not for SDM630-Standard V2**

The meter provides a function to reset the maximum demand value of current and power.



From the set-up menu, use **M** and **P** buttons to select the reset option.



Press **E** to enter the selection routine. The MD will flash.

Press **E** to confirm the reset and press **U/I** to return to the main set up menu.

### 4.8 Change Password

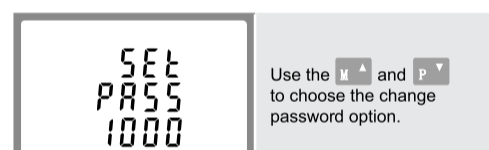

Use the **M** and **P** buttons to choose the change password option.



Press the **E** to enter the change password routine. The new password screen will appear with the first digit flashing.

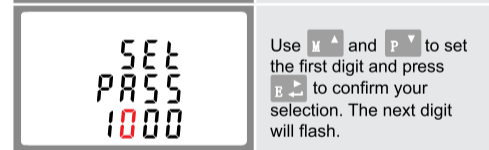

Use **M** and **P** to set the first digit and press **E** to confirm your selection. The next digit will flash.

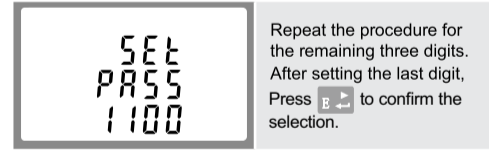

Repeat the procedure for the remaining three digits. After setting the last digit, Press **E** to confirm the selection.

Press **U/I** to exit the number setting routine and return to the Set-up menu.

## 5. Specifications

### 5.1 Measured Parameters

The unit can monitor and display the following parameters of a single phase two wire (1p2w), three phase three wire (3p3w) and three phase four wire (3p4w) system.

#### 5.1.1 Voltage and Current

**\*Not for SDM630-Standard V2**

- Phase to neutral voltages 176 to 276V a.c. (not for 3p3w supplies).
- Voltages between phases 304 to 480V a.c. (3p supplies only).
- Percentage total voltage harmonic distortion (THD%) for each phase to N (not for 3p3w supplies).
- Percentage voltage THD% between phases (three phase supplies only).
- Current THD% for each phase

#### 5.1.2 Power factor and Frequency and Max. Demand

**\*Not for SDM630-Standard V2**

- Frequency in Hz
- Power factor
- Instantaneous power:
- Power 0 to 99999 W
- Reactive power 0 to 99999 VAr
- Volt-amps 0 to 99999 VA
- Maximum demanded power since last Demand reset
- Maximum neutral demand current, since the last Demand reset (for three phase supplies only)

### 5.1.3 Energy Measurements

- Import active energy 0 to 999999.99 kWh
- Export reactive energy 0 to 999999.99 kVArh
- Import active energy 0 to 999999.99 kWh
- Export reactive energy 0 to 999999.99 kVArh
- Total active energy 0 to 999999.99 kWh
- Total reactive energy 0 to 999999.99 kVArh

### 5.2 Measured Inputs

Voltage inputs through 4-way fixed connector with 25mm<sup>2</sup> stranded wire capacity. single phase two wire (1p2w), three phase three wire (3p3w) or three phase four wire (3p4w) unbalanced. Line frequency measured from L1 voltage or L3 voltage.

Voltage AC (Un)	3x230(400)V
Voltage Range	80~120% Un
Base Current (Ib)	10A AC
Max. Current (Imax)	100A AC
Min. Current (Imin)	0.5A
Starting current	0.4% of Ib
Power consumption	≤ 2W/10VA for the voltage measuring circuit ≤ 4VA for the current measuring circuit

### 5.3 Interfaces for External Monitoring

Three interfaces are provided:

- RS485/Mbus communication channel that can be programmed for Modbus RTU/ Mbus protocol (not for SDM630-Pulse V2)
- Pulse output (pulse1) indicating real-time measured energy. (configurable)
- Pulse output (pulse2) 400imp/kWh (non-configurable)

### 5.4 Accuracy

- Voltage 0.5% of range maximum
- Current 0.5% of nominal
- Frequency 0.2% of mid-frequency
- Power factor 1% of unity (0.01)
- Active power (W) ± 1% of range maximum
- Reactive power (VAr) ± 1% of range maximum
- Apparent power (VA) ± 1% of range maximum
- Active energy (Wh) Class 1 IEC 62053-21  
Class B EN50470-1/3
- Reactive energy (VArh) Class 2 IEC 62053-23
- Response time to step input 1s, typical, to >99% of final reading, at 50 Hz.

### 5.5 Reference Conditions of Influence Quantities

Influence Quantities are variables that affect measurement errors to a minor degree. Accuracy is verified under nominal value (within the specified tolerance) of these conditions.

- Ambient temperature 23°C ± 2°C
- Input frequency 50 Hz (MID)  
50 or 60Hz ± 2% (non-MID)  
Sinusoidal (distortion factor < 0.005)
- Input waveform Sinusoidal (distortion factor < 0.005)
- Magnetic field of external origin Terrestrial flux

### 5.6 Environment

- Operating temperature -25°C to +55°C\*
- Storage temperature -40°C to +70°C\*
- Relative humidity 0 to 95%, non-condensing
- Altitude Up to 2000m
- Warm up time 5s
- Vibration 10Hz to 50Hz, IEC 60068-2-6, 2g
- Shock 30g in 3 planes

**\* Maximum operating and storage temperatures are in the context of typical daily and seasonal variation.**

### 5.7 Mechanics

- DIN rail dimensions 72 x 100 mm (WxH) per DIN 43880
- Mounting DIN rail (DIN35mm)
- Ingress protection IP51 (indoor)
- Material Self-extinguishing UL94 V-0

### 5.8 Declaration of Conformity (for the MID approved version meter only)

We Zhejiang Eastron Electronic Co., Ltd. Declare under our sole responsibility as the manufacturer that the poly phase multifunction electrical meter "SDM630 100A series" correspond to the production model described in the EU-type examination certificate and to the requirements of the Directive 2014/32/EU EU type examination certificate number 0120/SGS0151. Identification number of the NB0598

## 6. Dimensions

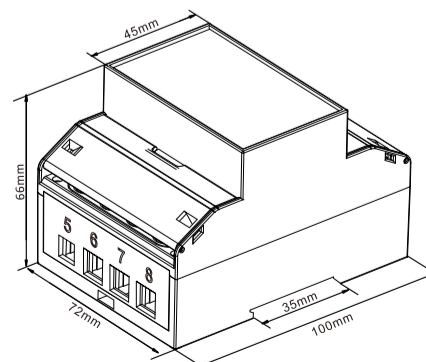

## 7. Wiring diagram

### single phase two wire

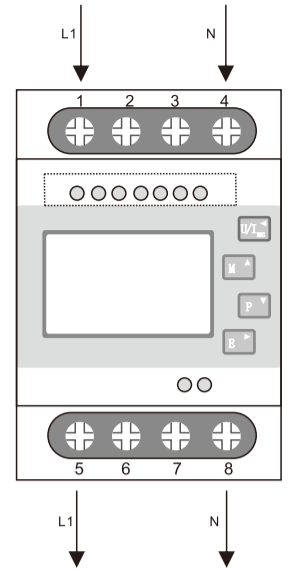

### three phase three wire

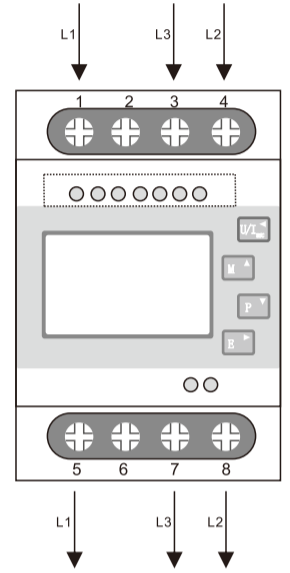

### three phase four wire

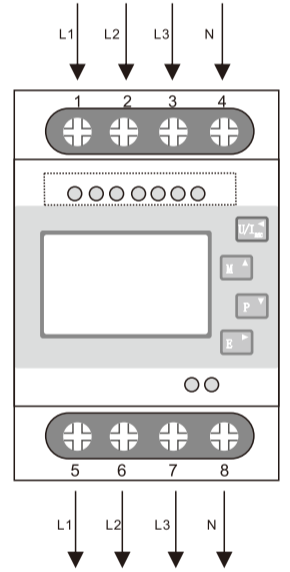

### Definitions of Other Terminals

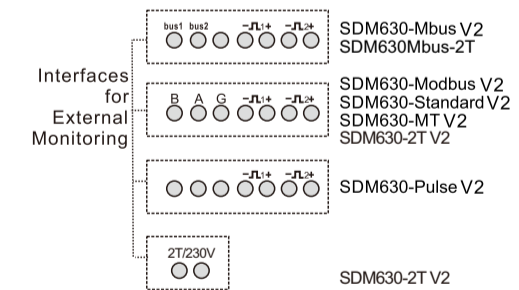

### 7.2 Terminals Capacity and Screw Torque

Terminals	Capacity	Screw Torque
COMM/Pulse/2T	0.5~1.5mm <sup>2</sup>	0.2Nm
Load	4~25mm <sup>2</sup>	2.5Nm

IMPORTER: Prima Group 2004 LTD,  
Bulgaria, 1784 Sofia, Mladost 1, bl. 144,  
Ground Floor; Phone: +359 2 988 45 72;



DH-SMS-0248